



Barcelona Stainless Bike Rack

The Barcelona Bike Rack delivers a practical solution for bicycle parking. Simple yet stylish these bike racks can be customised to stand out or blend in to their surroundings.



Customisation available

Quality & durability

- 304 grade stainless steel
- Satin finish
- Surface mounted or plant mounted
- Meets the AS 2890.3:2015 standard for bicycle parking facilities.

Ideal for

- Shopping centres
- Schools
- Streetscapes
- Parkscapes
- Universities

Finishes available

- Bead blasted finish
- Custom laser etching – your logo/design
- 316 grade stainless steel

Specifications

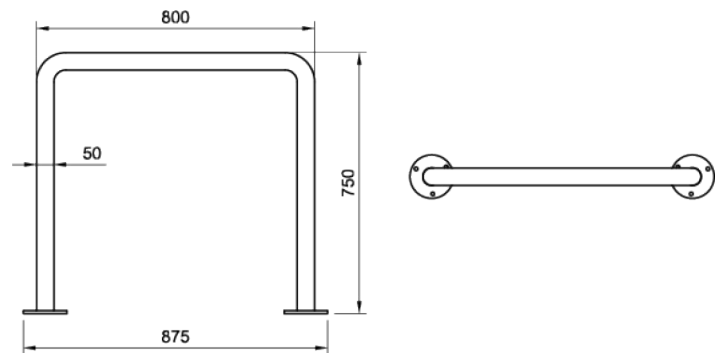

Contact us today

Freephone **0508 4 URBAN** or visit urbaneffects.co.nz