



## Denver Bus Shelter Standard

### Open Front- 2.4m to 5m

The Denver Shelter Standard, with open front design, offers versatile configurations to suit your unique shelter needs, ensuring durable, rust-free maintenance. Its smart design provides great coverage with minimal footprint. With an open front and optional seating, it prioritises your convenience and weather-proof durability.



Customisation  
available



5-Year Structural  
Warranty

### Quality & durability

- Aluminium construction- 90mm posts & rails
- Mini rib galvanised steel roof
- Shelter walls constructed with 10mm safety glass
- Open front
- Seating with space for wheelchair or strollers
- Modular design for various sizes
- Sizes available: 2.4m- 5m

### Ideal for

- Bus shelters
- Sports shelters
- Bike shelters
- Lunch shelters
- Chill out nook

### Finish

- Frame powder coated in Duralloy solid colour range of your choice.

### Options available

- Clear safety glass



- Clear safety glass with design



- Perforated Aluminium – Provides shelter with vandal resistant sides and ability to see through



- Aluminium lower panels, with glass upper panels

Contact us today

Freephone **0508 4 URBAN** or visit [urbaneffects.co.nz](http://urbaneffects.co.nz)



# Denver Bus Shelter Standard

## Open Front- 2.4m

The Denver Shelter Standard, with open front design, offers versatile configurations to suit your unique shelter needs, ensuring durable, rust-free maintenance. Its smart design provides great coverage with minimal footprint. With an open front and optional seating, it prioritises your convenience and weather-proof durability.



Customisation available



5-Year Structural Warranty

\*3.0m pictured

### Specifications

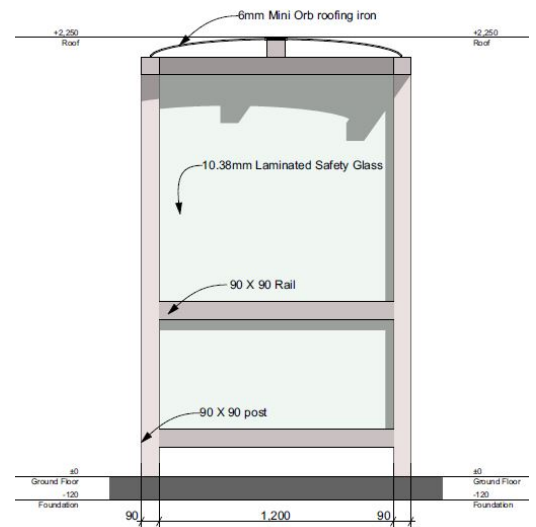
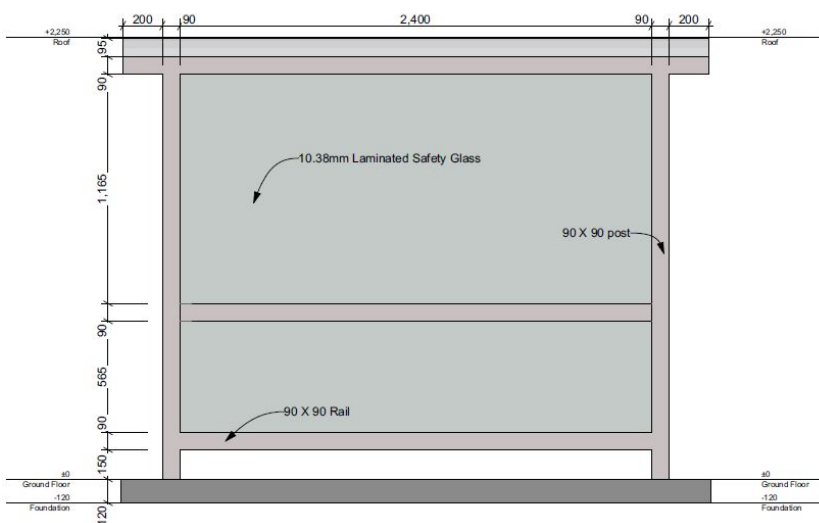
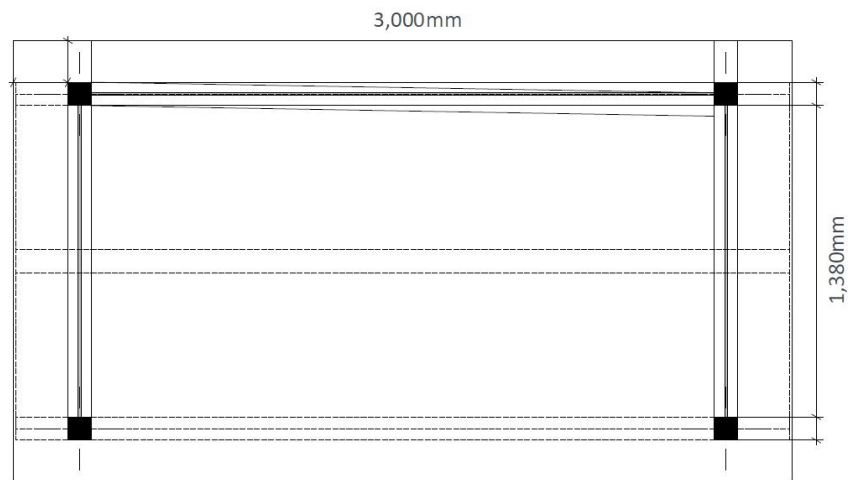
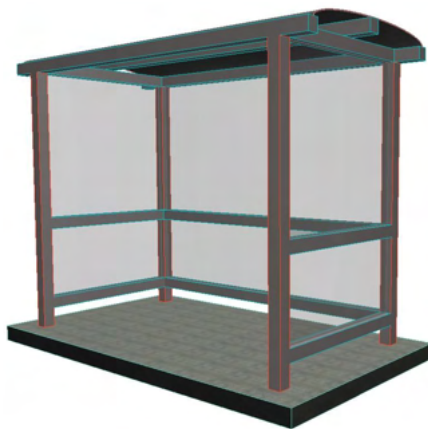

Contact us today

Freephone 0508 4 URBAN or visit [urbaneffects.co.nz](http://urbaneffects.co.nz)





# Denver Bus Shelter Standard Open Front- 3m

The Denver Shelter Standard, with open front design, offers versatile configurations to suit your unique shelter needs, ensuring durable, rust-free maintenance. Its smart design provides great coverage with minimal footprint. With an open front and optional seating, it prioritises your convenience and weather-proof durability.



Customisation available



5-Year Structural Warranty

## Specifications

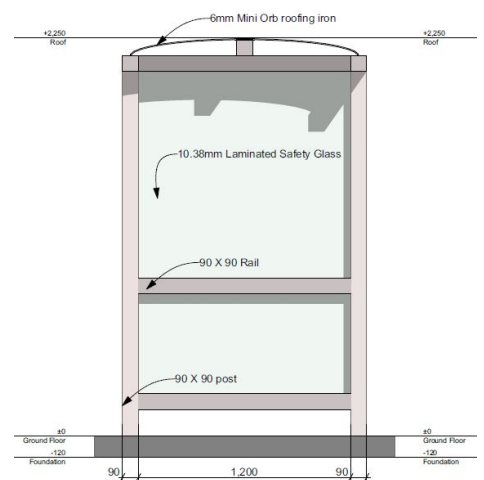
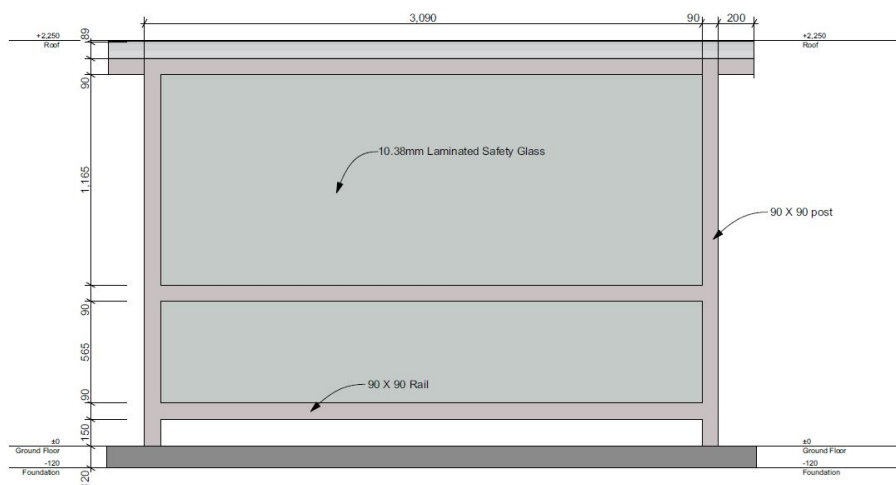
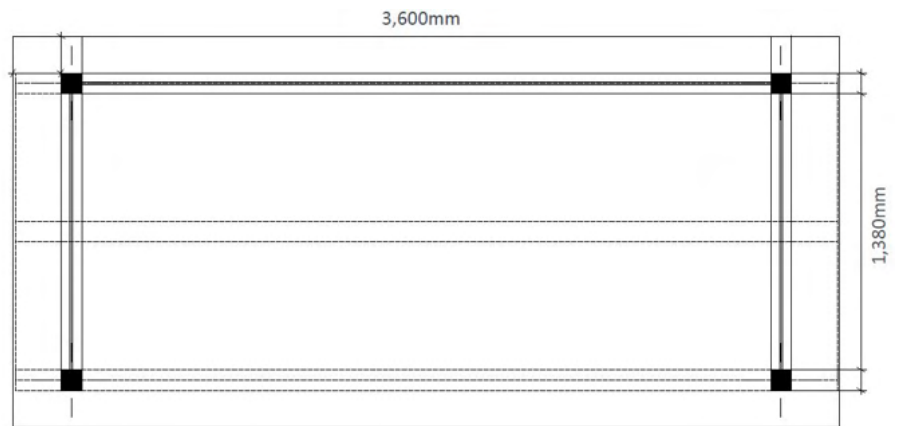
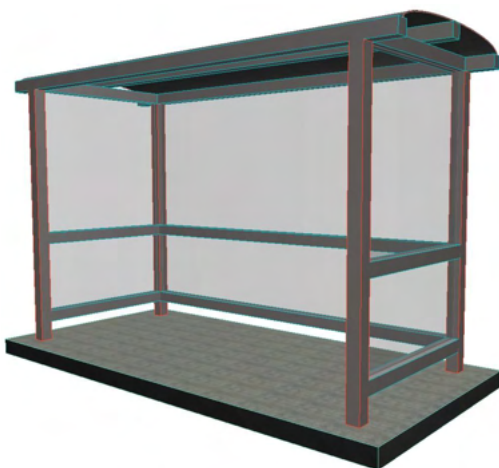

Contact us today

Freephone 0508 4 URBAN or visit [urbaneffects.co.nz](http://urbaneffects.co.nz)



# Denver Bus Shelter Standard Open Front- 3.6m

The Denver Shelter Standard, with open front design, offers versatile configurations to suit your unique shelter needs, ensuring durable, rust-free maintenance. Its smart design provides great coverage with minimal footprint. With an open front and optional seating, it prioritises your convenience and weather-proof durability.



Customisation available



5-Year Structural Warranty

\*3.0m pictured

## Specifications

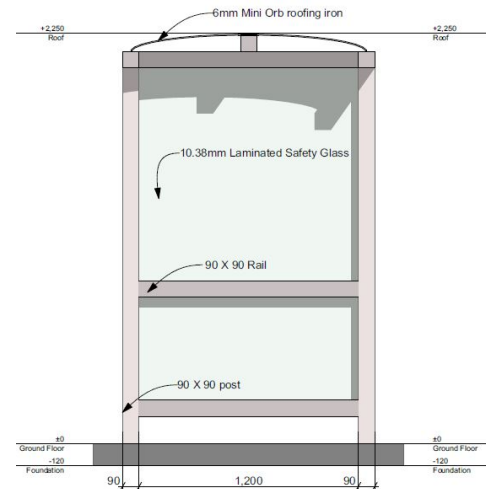
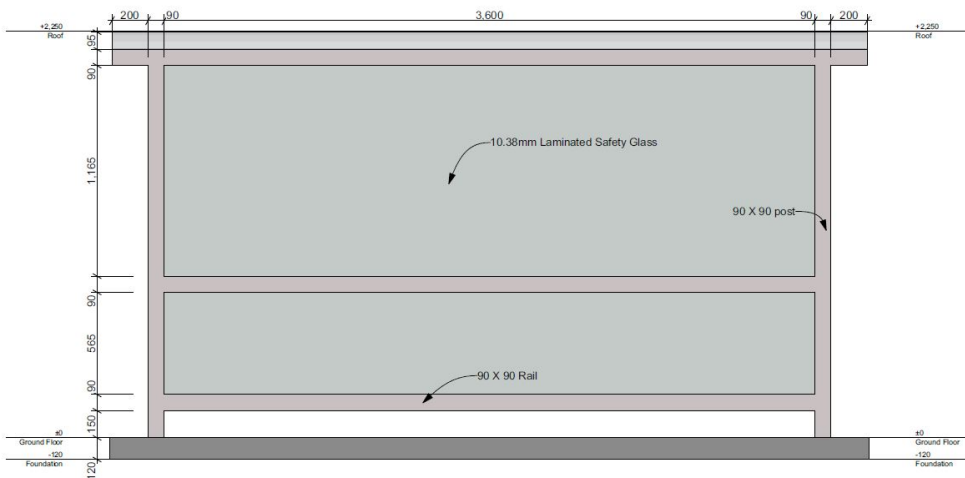
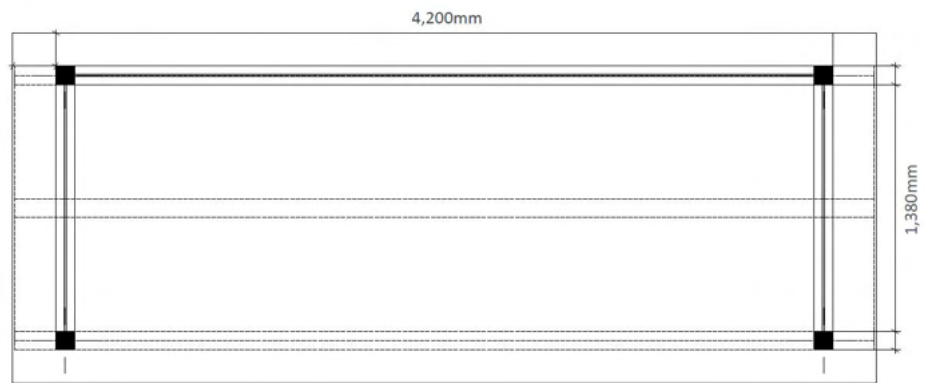
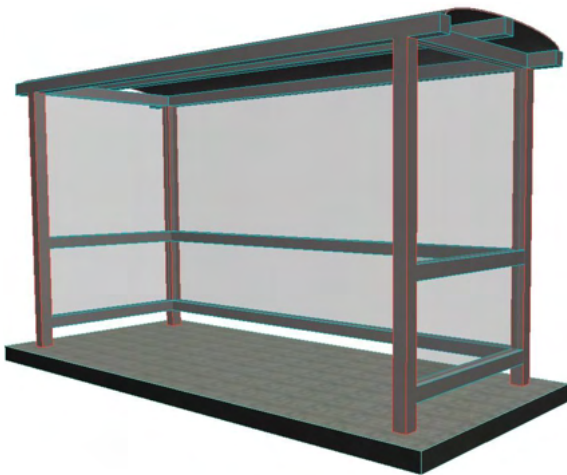

Contact us today

Freephone 0508 4 URBAN or visit [urbaneffects.co.nz](http://urbaneffects.co.nz)





\*3.0m pictured

# Denver Bus Shelter Standard Open Front- 5m

The Denver Shelter Standard, with open front design, offers versatile configurations to suit your unique shelter needs, ensuring durable, rust-free maintenance. Its smart design provides great coverage with minimal footprint. With an open front and optional seating, it prioritises your convenience and weather-proof durability.



Customisation available



5-Year Structural Warranty

## Specifications

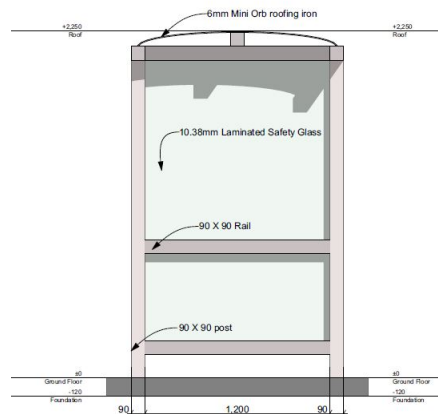
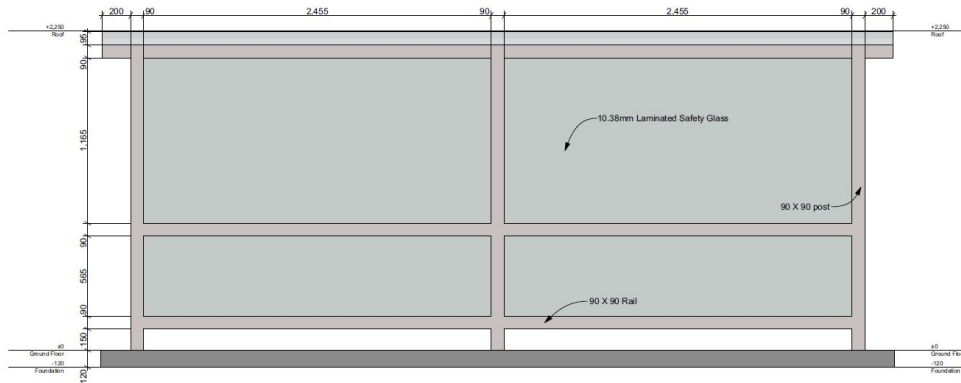
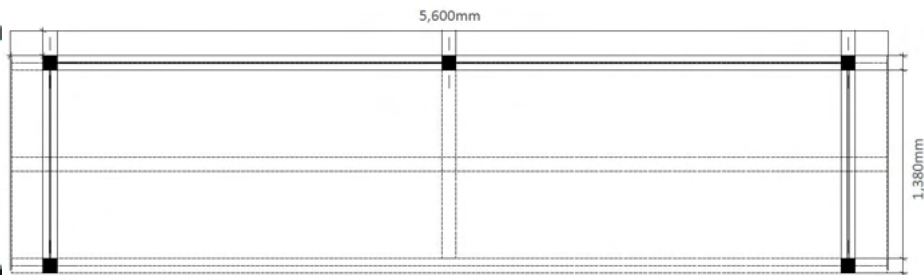

Contact us today

Freephone 0508 4 URBAN or visit [urbaneffects.co.nz](http://urbaneffects.co.nz)