



## Denver Bus Shelter Slimline

- 2.4m to 5m

The Denver Shelter Slimline is your solution for installations where achieving the required safe distance from the curb is challenging with standard designs. Contact us today to explore our range of available designs tailored to your needs.



Customisation  
available



5-Year Structural  
Warranty

### Quality & durability

- Aluminium construction- 90mm posts & rails
- Mini rib galvanised steel roof
- Shelter walls constructed with 10mm safety glass
- Open front
- Seating with space for wheelchair or strollers
- Modular design for various sizes
- Sizes available: 2.4m to 5m

### Ideal for

- Bus shelters
- Sports shelters
- Bike shelters
- Lunch shelters
- Chill out nook

### Finish

- Frame powder coated in Duralloy solid colour range of your choice.

### Options available

- Clear safety glass



- Clear safety glass with design



- Perforated Aluminium – Provides shelter with vandal resistant sides and ability to see through



- Aluminium lower panels, with glass upper panels

Contact us today

Freephone **0508 4 URBAN** or visit [urbaneffects.co.nz](http://urbaneffects.co.nz)



\*3.0m pictured

# Denver Bus Shelter Slimline

-2.4m

The Denver Shelter Slimline is your solution for installations where achieving the required safe distance from the curb is challenging with standard designs. Contact us today to explore our range of available designs tailored to your needs.



Customisation available



5-Year Structural Warranty

## Specifications

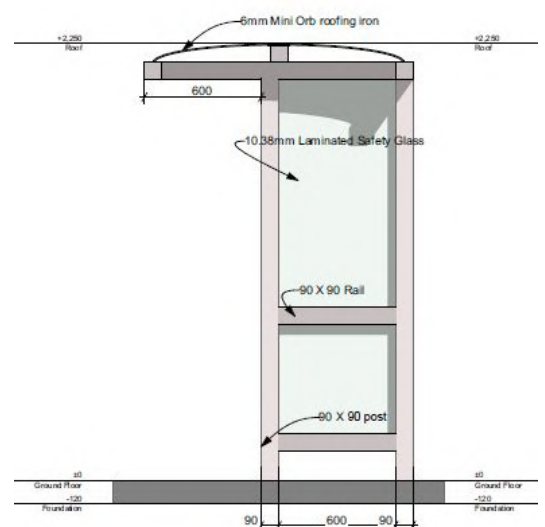
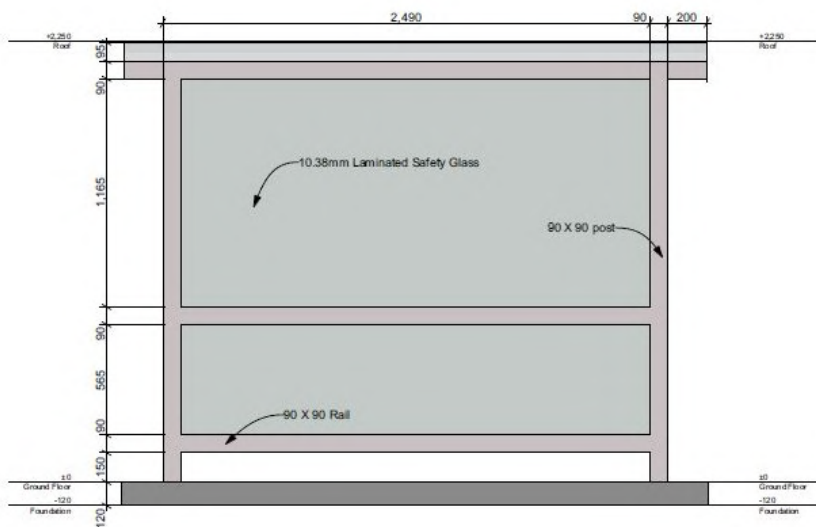
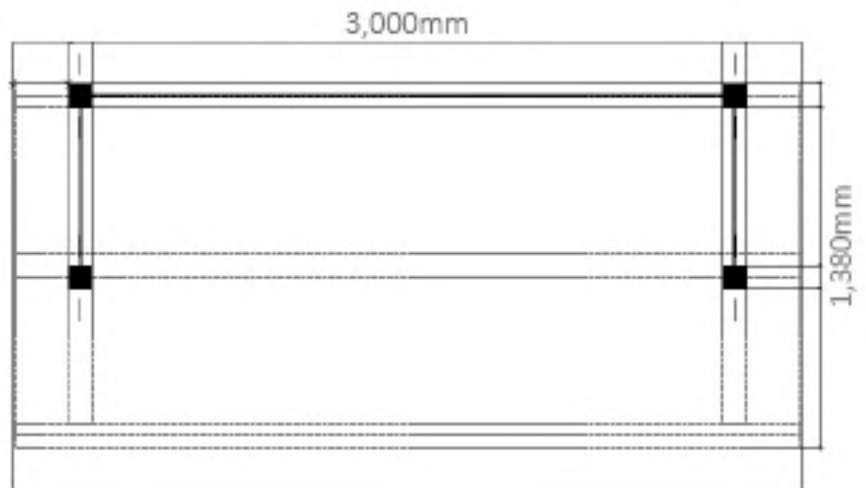

\*A wide range of colours are available to suit your desired colour scheme.

Contact us today

Freephone 0508 4 URBAN or visit [urbaneffects.co.nz](http://urbaneffects.co.nz)





# Denver Bus Shelter Slimline

-3m

The Denver Shelter Slimline is your solution for installations where achieving the required safe distance from the curb is challenging with standard designs. Contact us today to explore our range of available designs tailored to your needs.



Customisation available



5-Year Structural Warranty

## Specifications

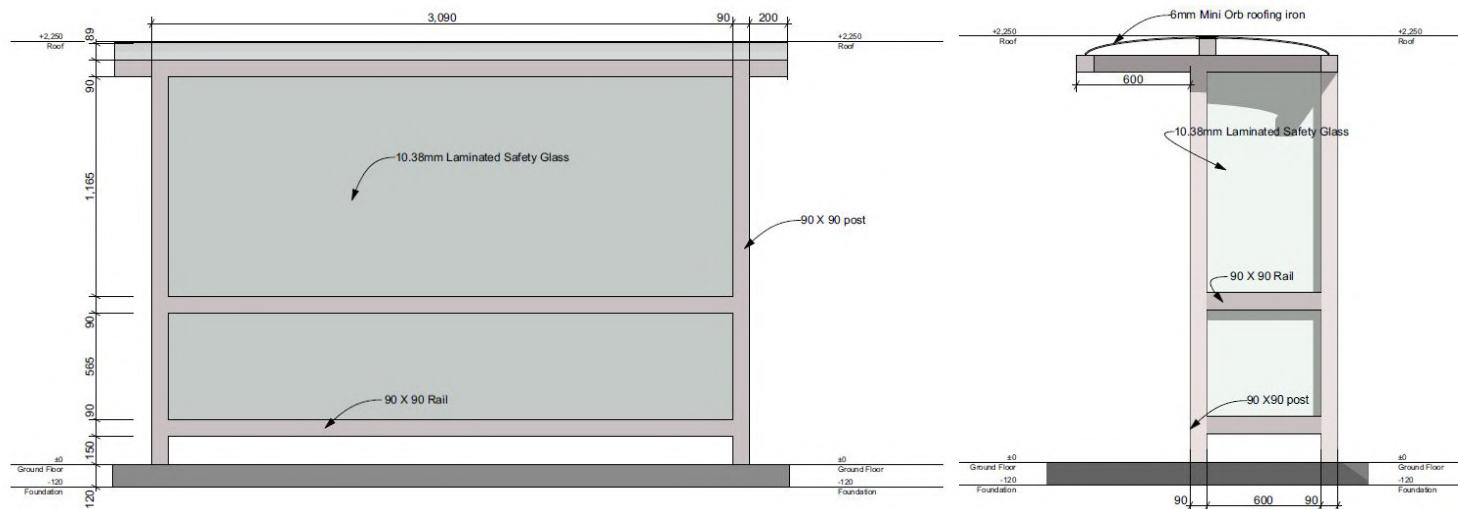
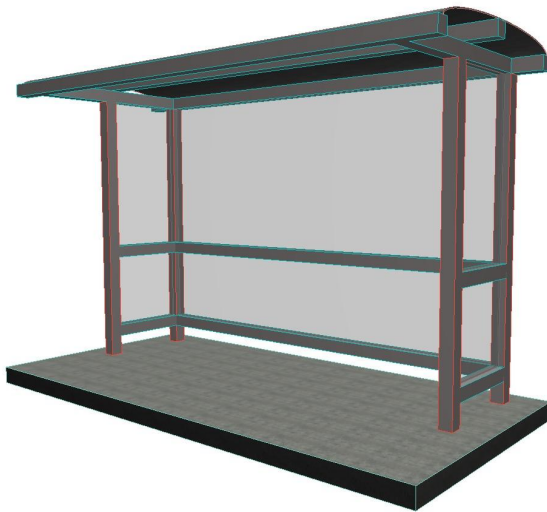

\*A wide range of colours are available to suit your desired colour scheme.

Contact us today

Freephone 0508 4 URBAN or visit [urbaneffects.co.nz](http://urbaneffects.co.nz)







# Denver Bus Shelter Slimline

## -3.6m

The Denver Shelter Slimline is your solution for installations where achieving the required safe distance from the curb is challenging with standard designs. Contact us today to explore our range of available designs tailored to your needs.



Customisation available



5-Year Structural Warranty

### Specifications

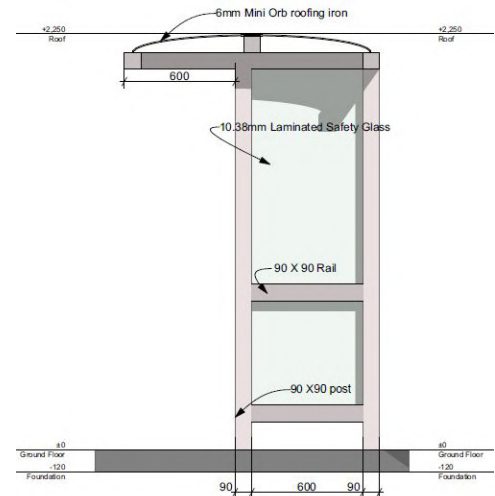
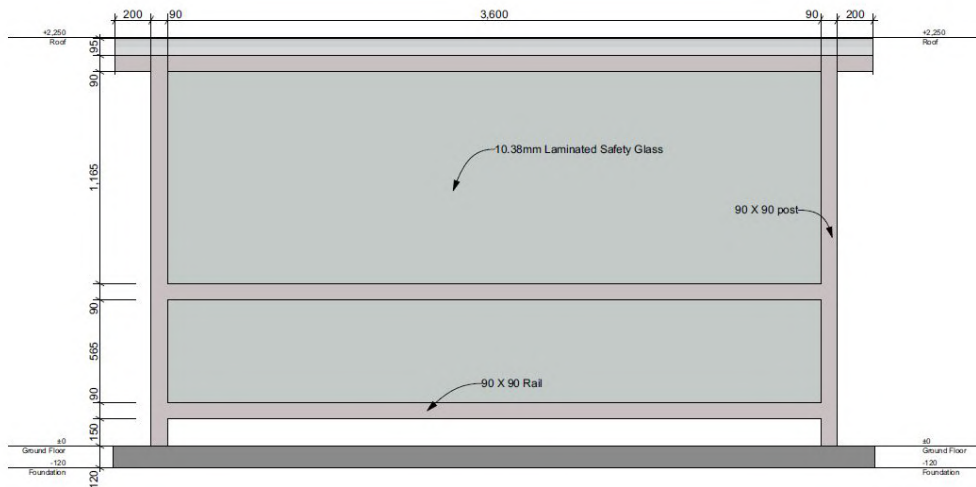
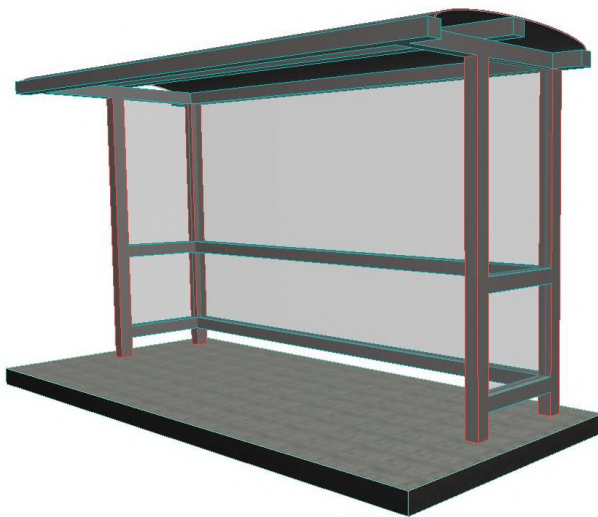

\*A wide range of colours are available to suit your desired colour scheme.

Contact us today

Freephone 0508 4 URBAN or visit [urbaneffects.co.nz](http://urbaneffects.co.nz)





# Denver Bus Shelter Slimline -5m

The Denver Shelter Slimline is your solution for installations where achieving the required safe distance from the curb is challenging with standard designs. Contact us today to explore our range of available designs tailored to your needs.



Customisation available



5-Year Structural Warranty



\*3.6m pictured

## Specifications

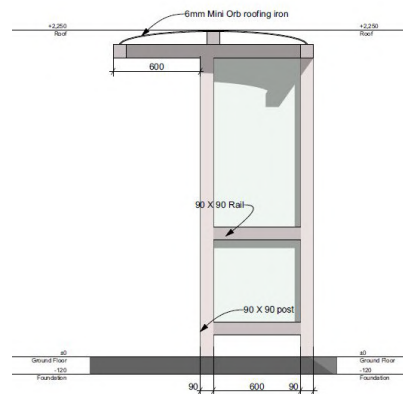
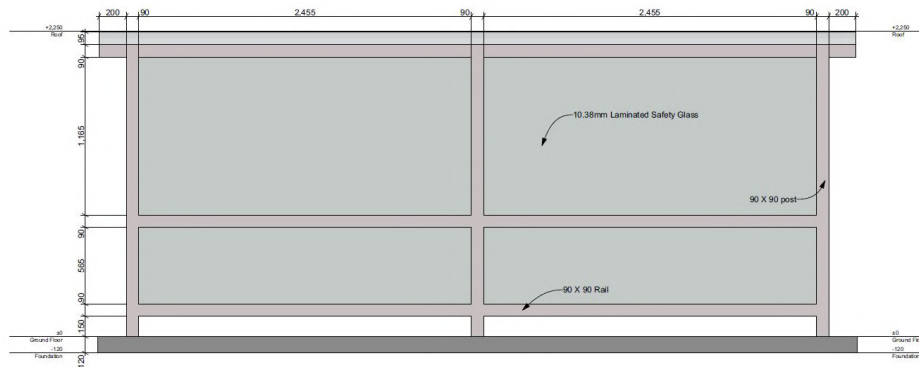
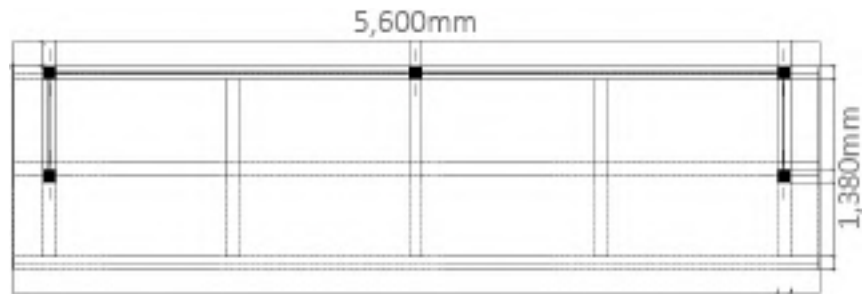
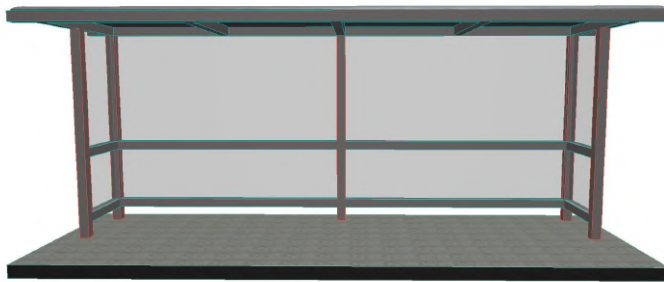

\*A wide range of colours are available to suit your desired colour scheme.

Contact us today

Freephone 0508 4 URBAN or visit [urbaneffects.co.nz](http://urbaneffects.co.nz)

